

300-TFC - POLY BOLTED FULL PORT TANK FITTING

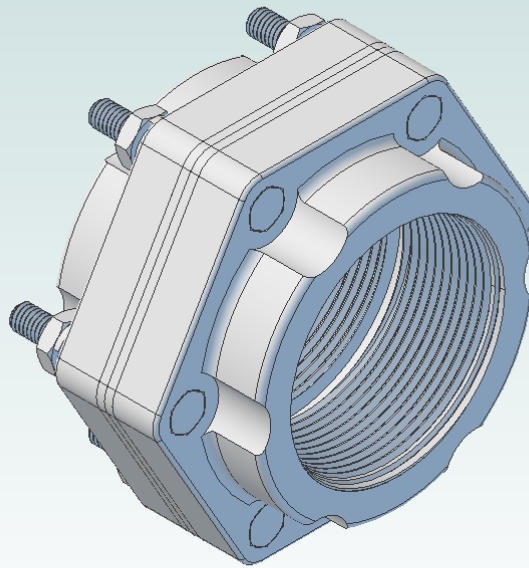

MATERIAL - POLYPROPYLENE
EPDM OR VITON
SS HARDWARE